

WAVECOM® W74LAN



The W74LAN decoder offers all the functions of the W74PC hardware and software decoder plus all the advantages of a compact and powerful computer system. The device is implemented in a ruggedized aluminium box with fanless cooling. W74LAN offers four completely independent Digital Down Converter inputs (DDC) at IF and AF level and supports dual channel simultaneous decoding on one card. W74LAN delivers a modern complete solution with various interfaces in hardware and software.



W74LAN

Complete Decoder System

WAVECOM®
NACHRICHTENTECHNIK

W74LAN Features and Facts

- ◆ W74LAN provides all functions required to analyze, decode, record and process radio data communications throughout the radio spectrum from HF to SHF. Decoder software covers all functionalities of W-CODE.
- ◆ W74LAN offers automated or manual monitoring of radio data and voice communications from HF to SHF bands.
- ◆ W74LAN can be connected to a PC or notebook via LAN or may operate as a stand-alone system. As the W74LAN operates from 9-30 V DC power sources, it is very well suited for mobile use.
- ◆ W74LAN offers four high-quality DDC inputs with wideband frequency range. The DDCs extract the narrowband signal of interest from a broadband input signal. The extracted signal is then used for further analysis, decoding and recording.
- ◆ W74LAN supports Software Defined Radios (SDR), W-CLOUD, VSC, standard VACs and all I/Q data or digital inputs.
- ◆ Built-in SSD (1 TB) suitable for wideband signal recording.
- ◆ W74LAN supports remote control from other applications using third party software with TCP/IP and XML.
- ◆ A W74LAN decoder can be controlled from anywhere across the network, and its output can be sent to one or more applications on the network.
- ◆ System components for radio monitoring and decoding can be individually configured according to the requirements of the customer.
- ◆ The host computer is in a ruggedized aluminium box. The cableless construction enables an easy plug-in of extension components and cards. This reduces failure risk later by loose cables.
- ◆ With the fanless cooling system W74LAN is suitable to work in an adverse environment.

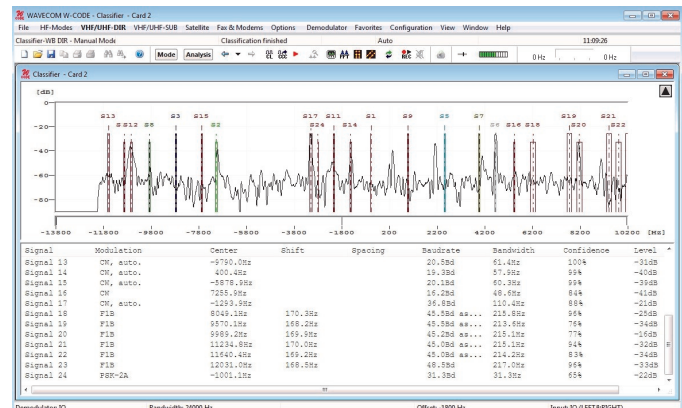

Classifier-WB display containing 24 identified signals



Simultaneous dual channel decoding on one W74PC card: STANAG4285 on AF#4 (instance 1) and SAT signals on IF70#1 (instance 2)

Signal Sources and Devices

- ◆ Two lines of decoding on one card: genuine simultaneous dual channel decoding of two different signals.
- ◆ W74LAN supports a great number of input interfaces and devices. The application processing the signal sources and devices for W74LAN is compatible with W-CODE.
- ◆ A number of other interfaces, e.g. SDR I/Q data or digital TCP/IP input streams using W-CLOUD, IP-PXGF, Virtual Audio Cable (VAC) or WinRADiO Digital Bridge Virtual Sound Card (VSC) and built-in soundcard input with sampling rates of up to 192 kHz, are also available with W74LAN.
- ◆ W74LAN is tested with a number of SDRs, e.g. WinRADiO G33DDC and G39DDC, Grintek GRXLAN, Perseus, netSDR, SDR-IP, SDR-IQ, Rohde & Schwarz receivers and MEDAV LR2.
- ◆ W74LAN supports direct digital I/Q input and output of WAV files with integrated Wavecom Media Player/Recorder.
- ◆ W74LAN offers two completely independent DDC (Digital Down Converter) inputs at IF and AF level from 0 – 25 MHz or 70 MHz +/-17.5 MHz. The two DDCs extract the narrowband signal of interest from a broadband input signal.
- ◆ DDCs correspond to the well-known Software Defined Radio (SDR) technology.

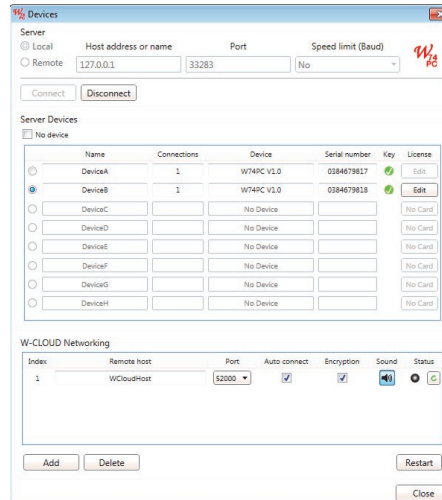

Device Selector in W74LAN: one card is listed as two decoder instances for simultaneous decoding

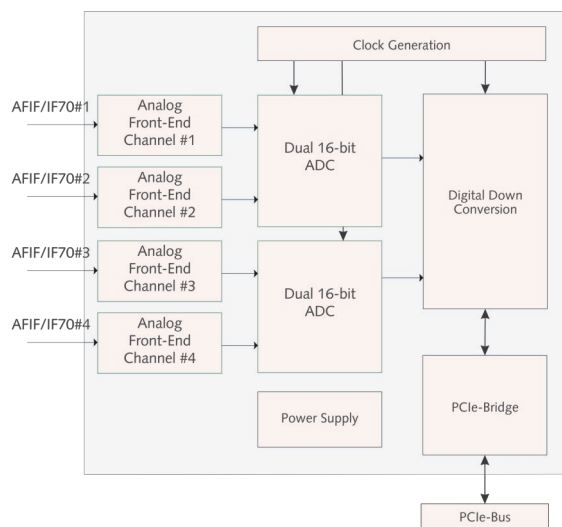

W74PC card block diagram

W74LAN

Complete Decoder System

WAVECOM®
NACHRICHTENTECHNIK

Wide Range of Applications

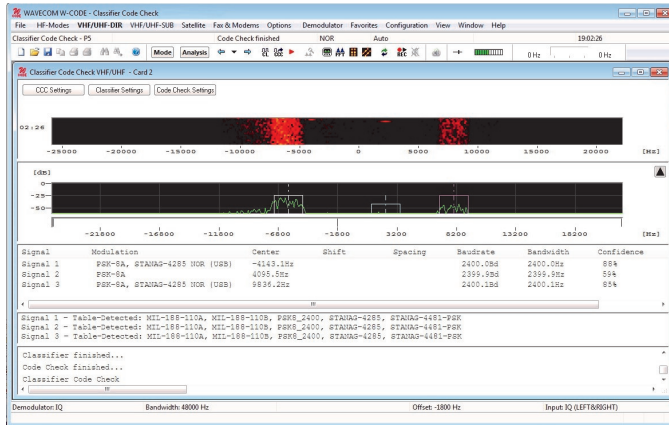

Automatic Signal Classification

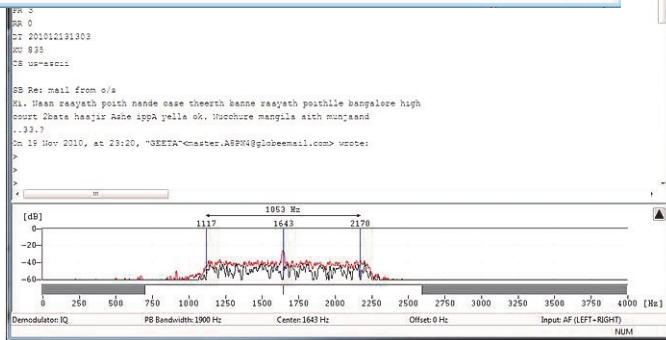

Data Decoding

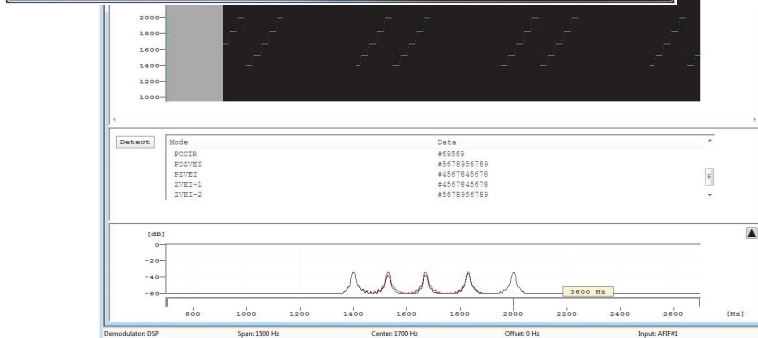

Signal Analysis

- Extraction (Mask)
- test STANAG 4285 Descrambler
- test Symbol Transcoding
- Extraction (Mask)
- test STANAG-4285 DeInterleaver
- test Stream setup for Viterbi
- Viterbi
- Mirroring
 - ASCII
 - UTF-8

Bit Analysis

W74LAN

Complete Decoder System

Practical Application

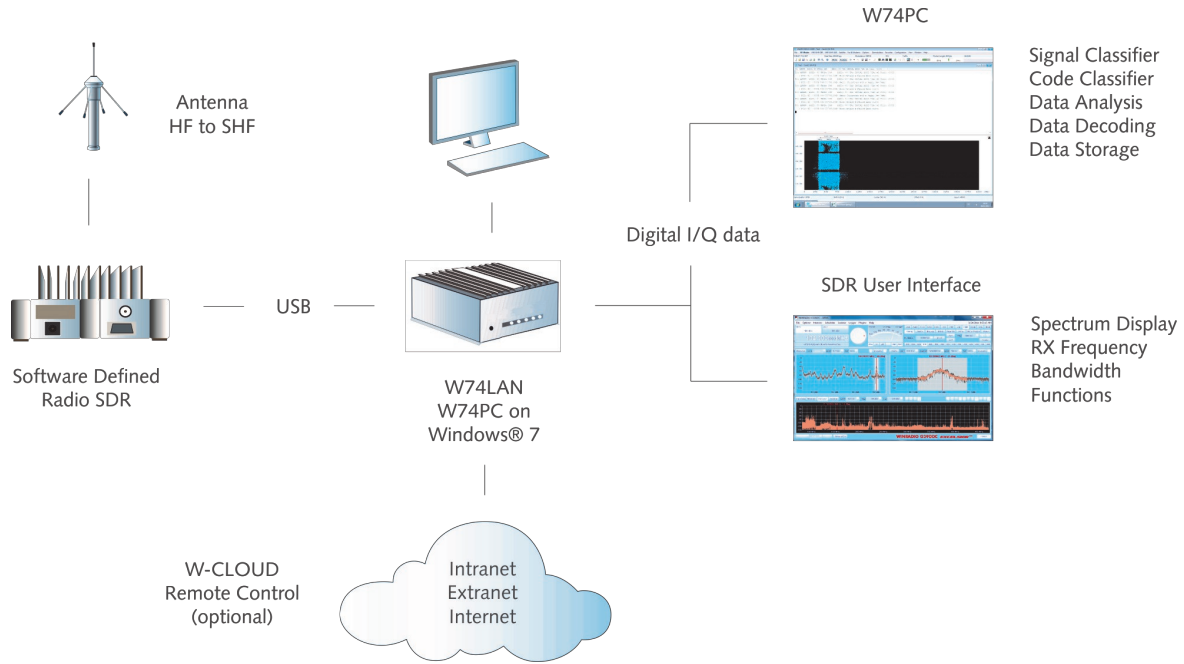

A W74LAN and WinRADIO SDR configuration

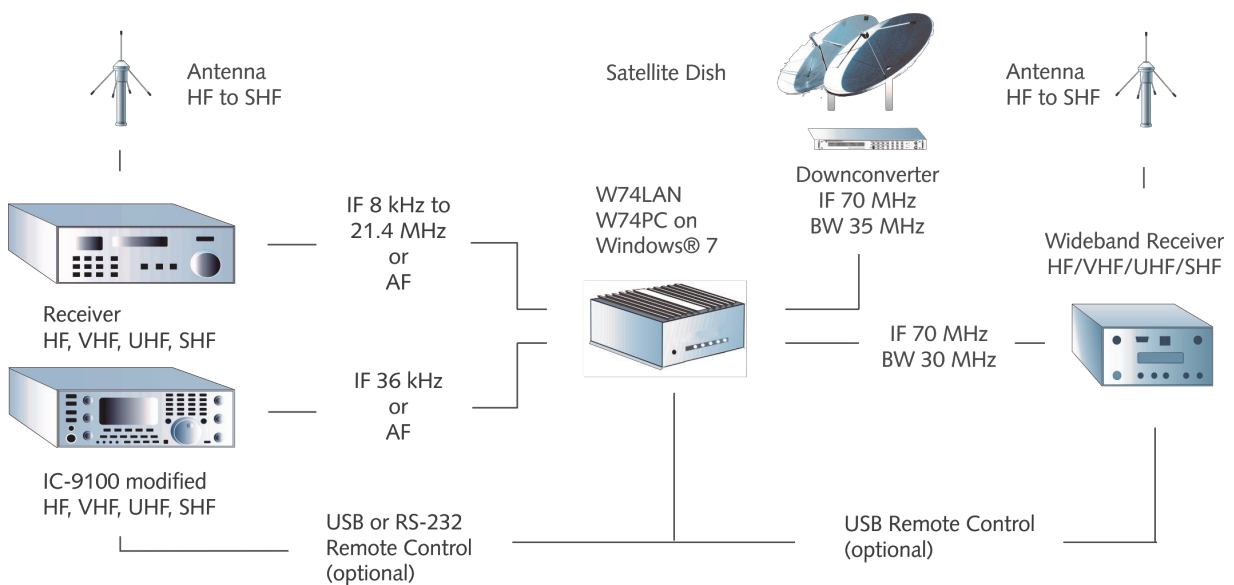





A W74LAN and IF receiver / downconverter configuration

W74LAN

Complete Decoder System

WAVECOM
NACHRICHTENTECHNIK

W74LAN Computer Specifications and Technical Data *

Dimensions (L x H x W)	227 x 126 x 216 mm
Weight	7.0 kg
DC power requirement (typical values)	9—48 V DC, 120 W, 24 V / 5 A
AC power requirement (typical values)	100—240 V, 50-60 Hz, 1.4 A
Operating temperature	-40 °C to 70 °C (According to IEC60068-2-1, IEC60068-2-2, IEC60068-2-14) Typically 55 °C at full decoding and monitoring operation
Case temperature range	-40 °C to 70 °C
Storage temperature range	-40 °C to 85 °C
Relative humidity	10 to 90 % (non-condensing)
Operating system (OS)	Windows 7 Professional, 64-bit, English
CPU	Intel® Core™ i7-6700TE, 8MB cache, Quad-core
CPU Clock	2.4 GHz
Controller	Desktop Intel® Q170 Platform Controller Hub
Memory	8 GB DDR4-RAM, PC2133, 260-pin memory DIMM
Hard disk (HDD) for operating system	250 GB, 7200, 64MB cache, 24h/7d
Solid state disk (SSD) for data storage	1000 GB, 540 MB/s, 1 GB cache
W-PCI-LAN	1 slot for W-PCI card 1 PCIe x 16 slot free
W-PCIe-LAN / W74LAN	1 slot PCIe x 16 for W-PCIe resp. W74PC card 1 PCI slot free
Ethernet / LAN	2 x 10MB/100MB/1GB
USB	2 x USB 3.0 (front), 4 x USB 3.0 (rear)
Serial ports	2 x RS232/422/485 (rear)
Audio	1 x Mic-in 1 x Line-out
Video	1 x DVI-I port, 2 x Display Ports (1 x front, 1 x rear) Intel® HD Graphics 530
Keyboard/Mouse	1 x PS/2 or USB
Conformity	 Trade Name WAVECOM Model Number Nise 3500P2  Tested To Comply with FCC Standards  EN 60601 Compliant 

(*) Technical data in the table is reference value. Product photo on the cover may change.





W74LAN

Complete Decoder System

WAVECOM®
NACHRICHTENTECHNIK

W74PC Card Specifications and Technical Data

Inputs	AFIF#1 — AFIF#4	IF70#1 — IF70#4
Connector	SMA female	SMA female
Frequency range	50 Hz to 25 MHz	52.5 MHz to 87.5 MHz (SAW filter)
Bandwidth	5 kHz to 500 kHz	5 kHz to 500 kHz
Frequency raster DDC	< 1.0 Hz	< 1.0 Hz
Signal level	2 mVrms to 0.5 Vrms	20 mVrms to 2.5 Vrms
Input impedance	> 1 kOhm	50 Ohm
Input max sampling rate	98.304 MHz	98.304 MHz
Input sampling rate jitter	< 1 ps (RMS 12 kHz to 20 MHz)	< 1 ps (RMS 12 kHz to 20 MHz)
Available for mode group	HF / VHF / UHF / Fax and Modem	HF / VHF / UHF / SAT

Card type	Half-size PCIe card (PCI Express x 4 slot)
Number of concurrent, independent inputs	Four SMA connectors: AFIF/IF70#1 — AFIF/IF70#4, each switchable by a mini signal relay
Dimensions (L x W x H)	168 x 106 x 22 mm
Weight	0.15 kg
Power requirement (typical values)	< 25W
Bus interface	PCIe x4 Link 2 Gbit/s
Operating temperature range	0 °C to 50 °C
Case temperature range	0 °C to 55 °C
Storage temperature range	0 °C to 70 °C
Relative humidity	10 to 90 % (non-condensing)
A/D converter	2 x AD9268 dual 16 bit ADC
Dynamic range	> 60 dB
Digital down converter DDC	FPGA Cyclone IV
Oscillator and clock	High stability temperature compensated crystal oscillator Low phase noise clock distribution
Watchdog for on-board generated voltages	Yes
License key	Built-in license, no external USB dongle necessary
Conformity	   

W74LAN

Complete Decoder System

WAVECOM[®]
NACHRICHTENTECHNIK

Since more than thirty years Wavecom Elektronik AG has developed, manufactured and distributed high quality devices and software for the decoding and retrieval of information from wireless data communication in all frequency bands. The nature

of the data communication may be arbitrary, but commonly contains text, images and voice. The company is internationally established within this industry and maintains a longstanding, world-wide network of distributors and business partners.

Product Information

Products	http://www.wavecom.ch/product-summary.php
Datasheets	http://www.wavecom.ch/brochures.php
Specifications	http://www.wavecom.ch/product-specifications.php
Documentation	http://www.wavecom.ch/manuals.php
Online help	http://www.wavecom.ch/content/ext/DecoderOnlineHelp/default.htm
Software warranty	One year free releases and bug fixes, update by DVD
Hardware warranty	Two years hardware warranty
Prices	http://www.wavecom.ch/contact-us.php

Ordering Information

Product Code	Description
W74LAN	Robust aluminium box standalone PC, with a W74PC card and decoder software on a in-card license
WLV	Live voice output to the speaker. Option for W-CODE, W74PC, W-PCIe, W-PCI and W-SPECTRA
WCPT	Decryption option to get clear voice and text. For W-CODE, W74PC, W-PCIe, W-PCI and W-SPECTRA
WHWL2	Second license for simultaneous decoding. Available for W-PCI, W-PCIe and W74PC cards

Distributors and Regional Contacts

You will find a list of distributors and regional contacts at <http://www.wavecom.ch/distributors.php>

WAVECOM[®]

NACHRICHTENTECHNIK

WAVECOM ELEKTRONIK AG
8090 Zurich, Switzerland
E-Mail: sales@wavecom.ch
Internet: www.wavecom.ch

© WAVECOM ELEKTRONIK AG - Brochure 2025 - All rights reserved

Microsoft, Encarta, MSN and Windows are either registered trademarks or trademarks of Microsoft Corporation in the United States and/or other countries. WINRADIO[®] is a registered trademark of Radixon Group Pty. Ltd. and Rosetta Laboratories Pty Ltd. ICOM[®] logo is a registered trademark of Icom Incorporated (Japan) in Japan.